

M7419 SERIES

DC/DC POWER SUPPLY

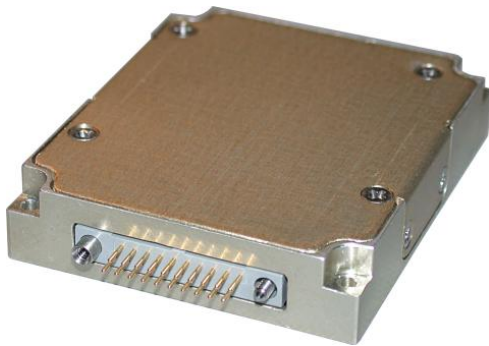

PRODUCT HIGHLIGHTS

- **MINIATURE**
- **HIGH DENSITY**
- **SINGLE OUTPUT**
- **DC/DC CONVERTER**
- **UP TO 50W**

Applications

Military (Airborne, ground-fix, shipboard), Ruggedized, Telecom, Industrial

Special Features

- Miniature size
- High efficiency
- Wide input range
- Input / Output isolation
- Remote sense compensation
- Remote Inhibit (On/Off)
- Fixed switching freq. (250 kHz)
- External sync. capability
- EMI filters included
- Conduction cooled
- Non-latching protections:
 - Overload/short-circuit
 - Over-voltage
 - Over temperature

Electrical Specifications

DC Input

Normal range: 18 to 48 V_{DC}

Not damaged (may restart) when exposed to surges IAW MIL-STD-1275A (100 V / 50 ms) and IAW MIL-STD-704A (80 V / 0.1 s)

Output Voltage Regulation

Better than or equal to ±1% (low to high line voltage, no load to full load, –55 °C to +85 °C at baseplate).

Ripple and Noise

Maximum 1% or less typical without external capacitance. When connected to system capacitance ripple drops significantly.

DC Output

Voltage range: 1.8 to 50 V_{DC}

Current: 0 to 10 A

Power: 0 to 50 W

Efficiency

Typically 70% to 80%, depending on output voltage.

Up to 83% @ 28 V_{DC} output, 28 V_{DC} input, full load and room temperature.

Load Transient Overshoot and undershoot

Output resistance at load change of 50%-100% is 30-70 mΩ (depending on output voltage). Output back to steady stated within 300-500 μs

Isolation

Input to Output: 200 V_{DC}

Input to Case: 200 V_{DC}

Output to Case: 100 V_{DC}

EMC

Complies with MIL-STD-1686 Indirect 4 kV ESD.

Designed to meet* MIL-STD-461F CE101, CE102, CS101, CS114, CS115, CS116, RE101, RE102, RS101, RS103

Turn on Transient

No voltage overshoot during power on.

* Compliance achieved with 5μH LISN, shielded harness and static resistive load.

Protections [†]

Input

- **Under-Voltage Lockout**
Unit may shut down if input voltage drops below 16.5 ± 1 V.
- **Over-Voltage Lockout**
Unit may shut down if input voltage rises above 52 ± 2 V.
- **Reverse Polarity Protection- Optional please consult factory**

Output

- **Over-Voltage Protection**
Passive transorb, chosen at $120\% \pm 10\%$ of nominal voltage.
- **Current Limiting**
Continuous protection (10-30% above maximum current) for unlimited time (Hiccup).

General

- **Over temperature protection:** Shutdown if base plate temperature rises above $+105 \text{ }^\circ\text{C} \pm 5 \text{ }^\circ\text{C}$.
Auto recovery when baseplate cools down to $+95 \text{ }^\circ\text{C} \pm 5 \text{ }^\circ\text{C}$.

Environmental Conditions

Designed to meet MIL-STD-810F

Temperature

Methods 501.4 & 502.4
Operating: $-55 \text{ }^\circ\text{C}$ to $+85 \text{ }^\circ\text{C}$ (at baseplate)
Storage: $-55 \text{ }^\circ\text{C}$ to $+125 \text{ }^\circ\text{C}$ (ambient)

Vibration

Method 514.5
Procedure I
 $14.76 \text{ g}_{\text{rms}}$ 20-2000 Hz for 500 seconds at each of 3 perpendicular axes.

Altitude

Method 500.4
Procedures I – Storage/Air transport:
up to 70,000 ft. (non-operational)
Procedure II – Operation/Air Carriage:
up to 70,000 ft. (operational)

Shock

Method 516.5
Procedure I
50 g / 11 ms terminal peak half-sine shock pulse

Humidity

Method 507.4
Up to 95% RH

Salt Fog

Method 509.4

Reliability

150,000 hours, calculated IAW MIL-HDBK-217F Notice 2 at $+85 \text{ }^\circ\text{C}$ baseplate, Ground fixed conditions.

Efficiency vs. Load

- 5 V_{DC} output:

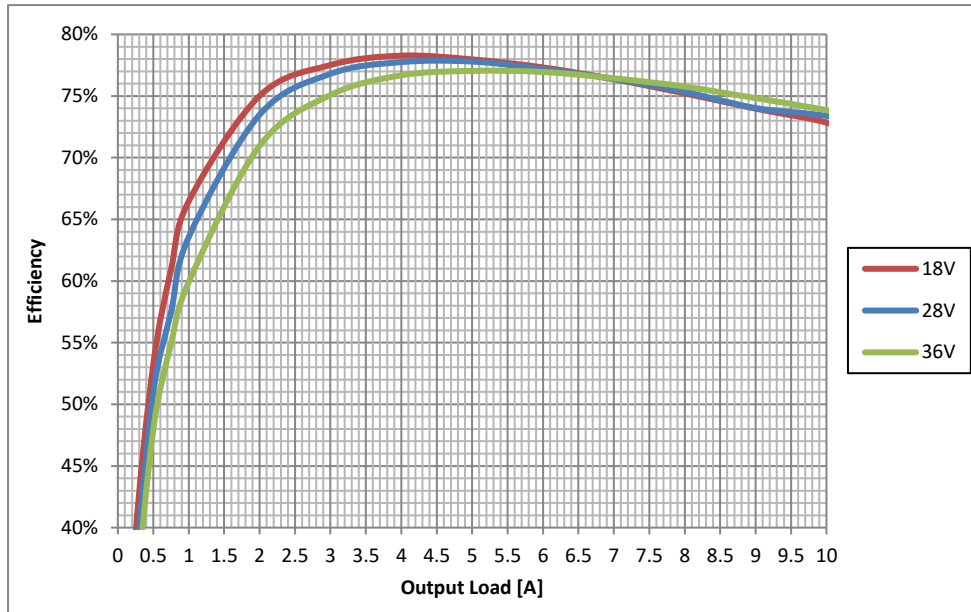

- 28 V_{DC} output:

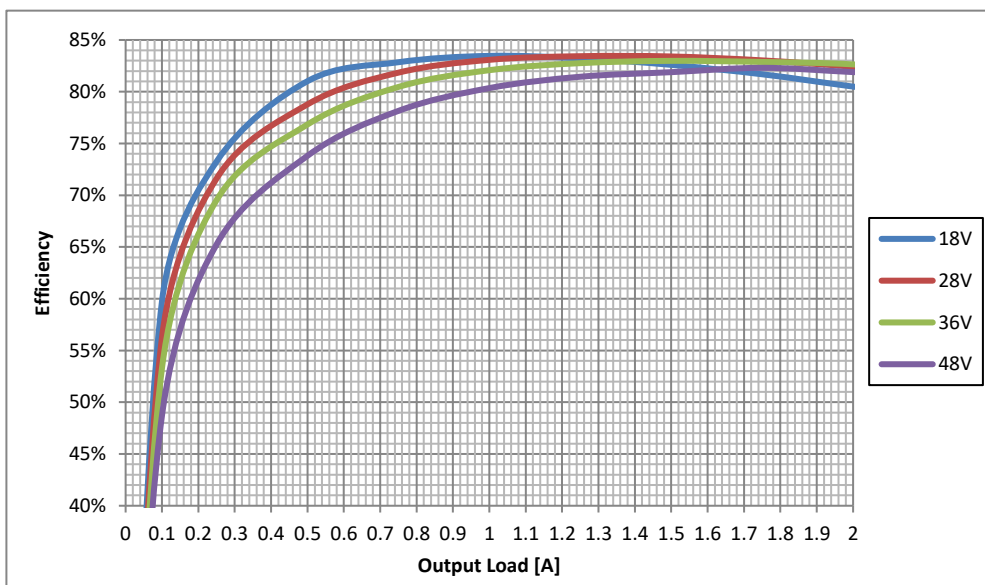

Pin Assignment

Connector type: RM272-020-322-2900 or eq.

Mates with: RM242-020-571-5900 (crimp removable contacts) or RM242-020-241-5900 (solder cup contacts) or eq.

Pin #	Function	Polarity	
1	INPUT	+	●
2	INPUT	+	●
3	INPUT RTN	–	●
4	INHIBIT	+	●
5	SYNC	+	●
6	SENSE RTN	–	●
7	OUTPUT RTN	–	●
8	OUTPUT RTN	–	●
9	OUTPUT	+	●
10	OUTPUT	+	●

Pin #	Function	Polarity	
11	INPUT	+	●
12	INPUT RTN	–	●
13	INPUT RTN	–	●
14	N.C.		
15	N.C.		
16	SENSE	+	●
17	OUTPUT RTN	–	●
18	OUTPUT RTN	–	●
19	OUTPUT	+	●
20	OUTPUT	+	●

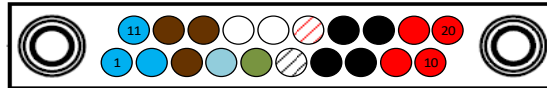

Note: All output pins with the same function should be connected together for best performance.

Functions and Signals

INHIBIT signal

The INHIBIT signal is used to turn the power supply ON and OFF.

TTL “1” or OPEN – will turn on the power supply. (For normal operation leave the signal not connected.)

TTL “0” – will turn off the power supply.

Grounding for signal is VIN RTN pin.

SYNC signal

The SYNC signal is used to allow the power supply frequency to sync with the system frequency.

SYNC frequency can be 250 ± 10 kHz, TTL level.

When left open, the power supply will work at 250 ± 10 kHz (internal clock).

This signal is referenced to VIN RTN pin.

SENSE

The SENSE is used to achieve accurate load regulations at load terminals (this is done by connecting the pins directly to the load’s terminals).

The use of remote sense has a limit of voltage dropout between converter’s output and load terminals of

2-10% of voltage output.

When not used connect SENSE to VOUT and SENSE RTN to VOUT RTN.

Typical Connection Diagram

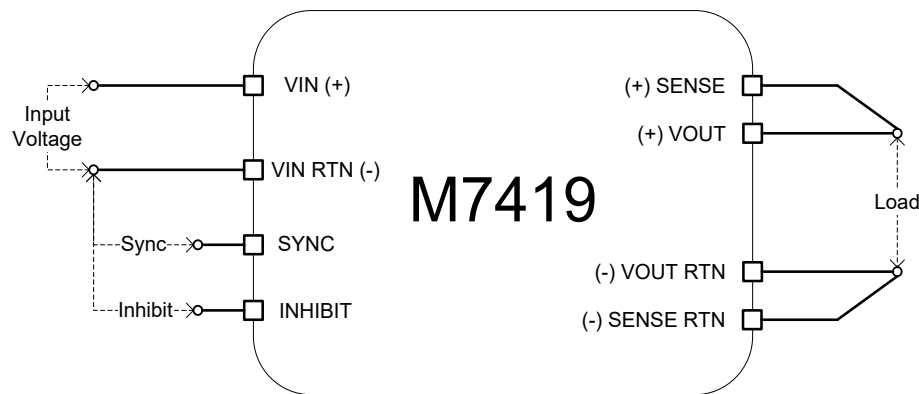

Outline Drawing

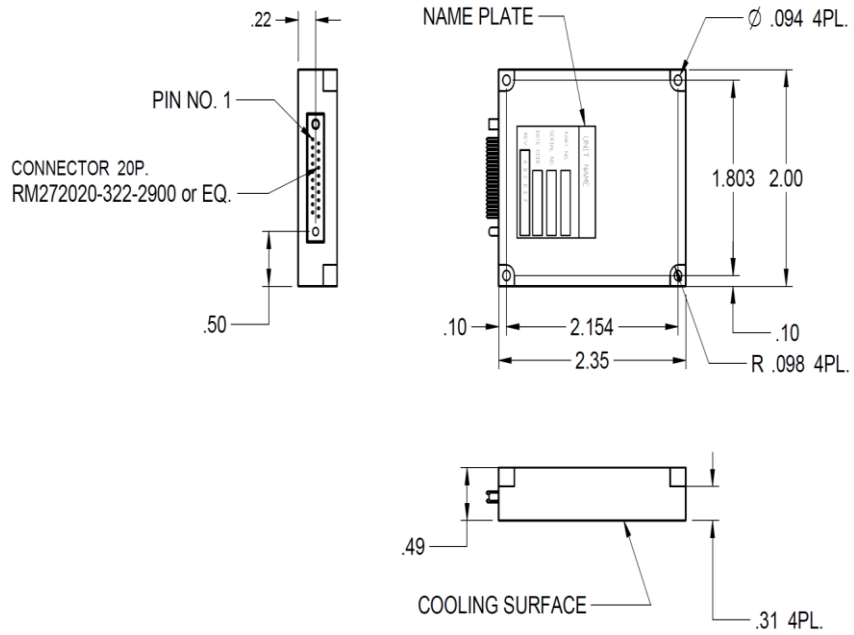

Heat Dissipation Surface

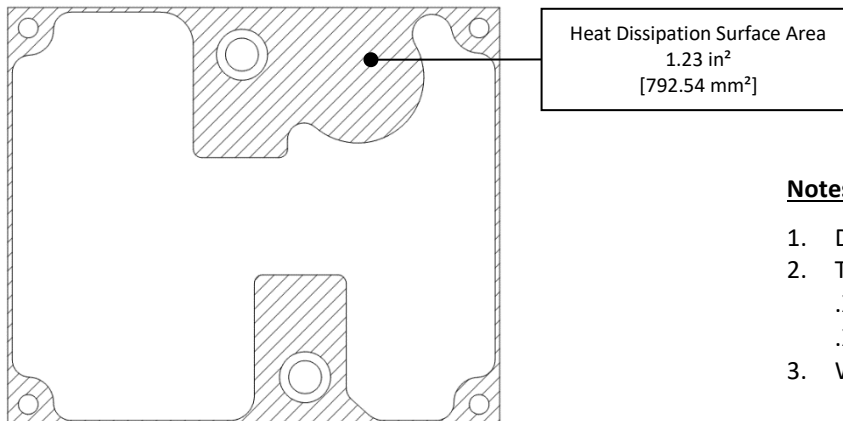

Notes

1. Dimensions are in inches [mm]
2. Tolerance is:
.XX ± 0.01 in
.XXX ± 0.005 in
3. Weight: Approx. 2.5 oz [70 g]

Standard Variants

Part number	Input configuration	Output configuration
M7419-100	18-48 V _{DC}	5 V _{DC} / 8 A
M7419-101	18-48 V _{DC}	12 V _{DC} / 3 A
M7419-102	18-48 V _{DC}	15 V _{DC} / 2.5 A
M7419-103	18-48 V _{DC}	24 V _{DC} / 2 A
M7419-104	18-48 V _{DC}	28 V _{DC} / 1.8 A
M7419-105	18-48 V _{DC}	48 V _{DC} / 0.8 A
M7419-106	18-50 V _{DC}	24 V _{DC} / 2 A
M7419-800*	18-48 V _{DC}	5 V _{DC} / 8 A
M7419-801*	18-48 V _{DC}	12 V _{DC} / 3 A
M7419-802*	18-48 V _{DC}	15 V _{DC} / 2.5 A
M7419-803*	18-48 V _{DC}	24 V _{DC} / 2 A
M7419-804*	18-48 V _{DC}	28 V _{DC} / 1.8 A
M7419-805*	18-48 V _{DC}	48 V _{DC} / 0.8 A
M7419-806*	18-50 V _{DC}	24 V _{DC} / 2 A

* This Product is REACH Compliant.

* The aluminum parts comprising this converter are chromate conversion coated per MIL-DTL-5541F, Type II CLASS 1A or eq.

Note: Specifications are subject to change without prior notice by the manufacturer.